



**COMMONWEALTH OF PENNSYLVANIA
DEPARTMENT OF ENVIRONMENTAL PROTECTION
AIR QUALITY PROGRAM**

STATE ONLY SYNTHETIC MINOR OPERATING PERMIT

Issue Date:	March 10, 2022	Effective Date:	March 25, 2022
Revision Date:	March 25, 2022	Expiration Date:	March 9, 2027
Revision Type:	Amendment		

In accordance with the provisions of the Air Pollution Control Act, the Act of January 8, 1960, P.L. 2119, as amended, and 25 Pa. Code Chapter 127, the Owner, [and Operator if noted] (hereinafter referred to as permittee) identified below is authorized by the Department of Environmental Protection (Department) to operate the air emission source(s) more fully described in this permit. This Facility is subject to all terms and conditions specified in this permit. Nothing in this permit relieves the permittee from its obligations to comply with all applicable Federal, State and Local laws and regulations.

The regulatory or statutory authority for each permit condition is set forth in brackets. All terms and conditions in this permit are federally enforceable unless otherwise designated.

State Only Permit No: 19-00004

Synthetic Minor

Federal Tax Id - Plant Code: 23-3027736-1

Owner Information

Name: CHEETAH CHASSIS CORP
Mailing Address: PO BOX 388
3RD & OAK ST
BERWICK, PA 18603-0388

Plant Information

Plant: CHEETAH CHASSIS CORP/BERWICK PLT
Location: 19 Columbia County 19001 Berwick Borough
SIC Code: 3715 Manufacturing - Truck Trailers

Responsible Official

Name: GARRY HARTMAN
Title: PRES
Phone: (570) 752 - 2709 Email: ghartman@cheetahchassis.com

Permit Contact Person

Name: GARRY HARTMAN
Title: PRES
Phone: (570) 752 - 2709 Email: ghartman@cheetahchassis.com

[Signature] _____
MUHAMMAD Q. ZAMAN, ENVIRONMENTAL PROGRAM MANAGER, NORTHCENTRAL REGION



SECTION A. Table of Contents

Section A. Facility/Source Identification

Table of Contents
Site Inventory List

Section B. General State Only Requirements

- #001 Definitions.
- #002 Operating Permit Duration.
- #003 Permit Renewal.
- #004 Operating Permit Fees under Subchapter I.
- #005 Transfer of Operating Permits.
- #006 Inspection and Entry.
- #007 Compliance Requirements.
- #008 Need to Halt or Reduce Activity Not a Defense.
- #009 Duty to Provide Information.
- #010 Revising an Operating Permit for Cause.
- #011 Operating Permit Modifications
- #012 Severability Clause.
- #013 De Minimis Emission Increases.
- #014 Operational Flexibility.
- #015 Reactivation
- #016 Health Risk-based Emission Standards and Operating Practice Requirements.
- #017 Circumvention.
- #018 Reporting Requirements.
- #019 Sampling, Testing and Monitoring Procedures.
- #020 Recordkeeping.
- #021 Property Rights.
- #022 Alternative Operating Scenarios.
- #023 Reporting
- #024 Report Format

Section C. Site Level State Only Requirements

- C-I: Restrictions
- C-II: Testing Requirements
- C-III: Monitoring Requirements
- C-IV: Recordkeeping Requirements
- C-V: Reporting Requirements
- C-VI: Work Practice Standards
- C-VII: Additional Requirements
- C-VIII: Compliance Certification
- C-IX: Compliance Schedule

Section D. Source Level State Only Requirements

- D-I: Restrictions
- D-II: Testing Requirements
- D-III: Monitoring Requirements
- D-IV: Recordkeeping Requirements
- D-V: Reporting Requirements
- D-VI: Work Practice Standards
- D-VII: Additional Requirements

Note: These same sub-sections are repeated for each source!

Section E. Source Group Restrictions

- E-I: Restrictions



SECTION A. Table of Contents

- E-II: Testing Requirements
- E-III: Monitoring Requirements
- E-IV: Recordkeeping Requirements
- E-V: Reporting Requirements
- E-VI: Work Practice Standards
- E-VII: Additional Requirements

Section F. Alternative Operating Scenario(s)

- F-I: Restrictions
- F-II: Testing Requirements
- F-III: Monitoring Requirements
- F-IV: Recordkeeping Requirements
- F-V: Reporting Requirements
- F-VI: Work Practice Standards
- F-VII: Additional Requirements

Section G. Emission Restriction Summary

Section H. Miscellaneous

**SECTION A. Site Inventory List**

Source ID	Source Name	Capacity/Throughput	Fuel/Material
031	6 SPACE HEATERS < 2.5 MMBTU/HR		
032	2 SPACE HEATERS >2.5 MMBTU/HR		
P101	CHASSIS PAINT BOOTH (LINE 1)		
P102	DEVILBISS SPRAY BOOTH (LINE 2)		
P103	EQUIPMENT CLEANUP ACTIVITIES		
P104	LINE 1 CURING OVEN	1.100 MMBTU/HR	
P105	SPRAY GUNS WASHER		
P106	SHOT BLAST BOOTHS		
C101	PARTICULATE FILTERS (LINE 1)		
C102	PARTICULATE FILTERS (LINE 2)		
C106	LINE 1 CARTRIDGE COLLECTOR		
C106A	LINE 2 CARTRIDGE COLLECTOR		
FM01	NATURAL GAS LINE		
S031	SPACE HEATER EXHAUST		
S032	SPACE HTR >2.5 EXHAUST		
S101A	CHASSIS BOOTH STACK A		
S101B	CHASSIS BOOTH STACK B		
S101C	CHASSIS BOOTH STACK C		
S101D	CHASSIS BOOTH STACK D		
S102	DEVILBISS BOOTH STACK		
Z103	CLEANUP SOLVENT FUGITIVES		
Z104	CURING OVEN FUGITIVE EMISSIONS		
Z105	PARTS WASHER FUGITIVES		
Z106	LINE 1 BLAST FUGITIVES		
Z106A	LINE 2 SHOT BLAST FUGITIVES		

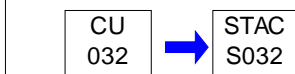
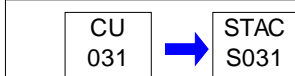
PERMIT MAPS



PERMIT MAPS

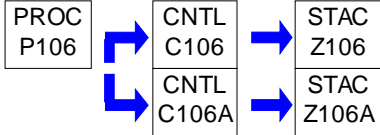
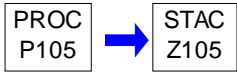
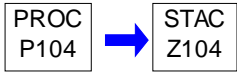
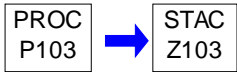
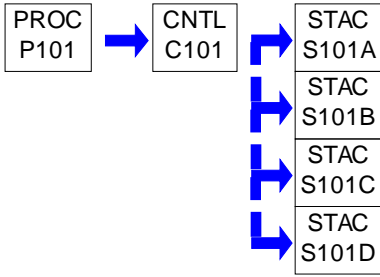

**SECTION B. General State Only Requirements****#001 [25 Pa. Code § 121.1]****Definitions.**

Words and terms that are not otherwise defined in this permit shall have the meanings set forth in Section 3 of the Air Pollution Control Act (35 P.S. § 4003) and in 25 Pa. Code § 121.1.

#002 [25 Pa. Code § 127.446]**Operating Permit Duration.**

(a) This operating permit is issued for a fixed term of five (5) years and shall expire on the date specified on Page 1 of this permit.

(b) The terms and conditions of the expired permit shall automatically continue pending issuance of a new operating permit, provided the permittee has submitted a timely and complete application and paid applicable fees required under 25 Pa. Code Chapter 127, Subchapter I and the Department is unable, through no fault of the permittee, to issue or deny a new permit before the expiration of the previous permit.

#003 [25 Pa. Code §§ 127.412, 127.413, 127.414, 127.446 & 127.703(b)]**Permit Renewal.**

(a) The permittee shall submit a timely and complete application for renewal of the operating permit to the appropriate Regional Air Program Manager. The application for renewal of the operating permit shall be submitted at least six (6) months and not more than 18 months before the expiration date of this permit.

(b) The application for permit renewal shall include the current permit number, a description of any permit revisions that occurred during the permit term, and any applicable requirements that were promulgated and not incorporated into the permit during the permit term. An application is complete if it contains sufficient information to begin processing the application, has the applicable sections completed and has been signed by a responsible official.

(c) The permittee shall submit with the renewal application a fee for the processing of the application as specified in 25 Pa. Code § 127.703(b). The fees shall be made payable to "The Commonwealth of Pennsylvania Clean Air Fund" and submitted with the fee form to the respective regional office.

(d) The renewal application shall also include submission of proof that the local municipality and county, in which the facility is located, have been notified in accordance with 25 Pa. Code § 127.413.

(e) The application for renewal of the operating permit shall also include submission of supplemental compliance review forms in accordance with the requirements of 25 Pa. Code § 127.412(b) and § 127.412(j).

(f) The permittee, upon becoming aware that any relevant facts were omitted or incorrect information was submitted in the permit application, shall promptly submit such supplementary facts or corrected information as necessary to address any requirements that become applicable to the source after the permittee submits a complete application, but prior to the date the Department takes action on the permit application.

#004 [25 Pa. Code § 127.703]**Operating Permit Fees under Subchapter I.**

(a) The permittee shall pay the annual operating permit maintenance fee according to the following fee schedule in either paragraph (1) or (2) in accordance with 25 Pa. Code § 127.703(d) on or before December 31 of each year for the next calendar year.

(1) For a synthetic minor facility, a fee equal to:

(i) Four thousand dollars (\$4,000) for calendar years 2021—2025.

(ii) Five thousand dollars (\$5,000) for calendar years 2026—2030.

(iii) Six thousand three hundred dollars (\$6,300) for the calendar years beginning with 2031.

**SECTION B. General State Only Requirements**

(2) For a facility that is not a synthetic minor, a fee equal to:

- (i) Two thousand dollars (\$2,000) for calendar years 2021—2025.
- (ii) Two thousand five hundred dollars (\$2,500) for calendar years 2026—2030.
- (iii) Three thousand one hundred dollars (\$3,100) for the calendar years beginning with 2031.

(b) The applicable fees shall be made payable to "The Commonwealth of Pennsylvania Clean Air Fund" with the permit number clearly indicated and submitted to the respective regional office.

#005 [25 Pa. Code §§ 127.450 (a)(4) and 127.464]**Transfer of Operating Permits.**

(a) This operating permit may not be transferred to another person, except in cases of transfer-of-ownership that are documented and approved by the Department.

(b) In accordance with 25 Pa. Code § 127.450(a)(4), a change in ownership of the source shall be treated as an administrative amendment if the Department determines that no other change in the permit is required and a written agreement has been submitted to the Department identifying the specific date of the transfer of permit responsibility, coverage and liability between the current and the new permittee and a compliance review form has been submitted to, and the permit transfer has been approved by, the Department.

(c) This operating permit is valid only for those specific sources and the specific source locations described in this permit.

#006 [25 Pa. Code § 127.441 and 35 P.S. § 4008]**Inspection and Entry.**

(a) Upon presentation of credentials and other documents as may be required by law, the permittee shall allow the Department or authorized representatives of the Department to perform the following:

(1) Enter at reasonable times upon the permittee's premises where a source is located or emissions related activity is conducted, or where records are kept under the conditions of this permit;

(2) Have access to and copy, at reasonable times, any records that are kept under the conditions of this permit;

(3) Inspect at reasonable times, any facilities, equipment including monitoring and air pollution control equipment, practices, or operations regulated or required under this permit;

(4) Sample or monitor, at reasonable times, any substances or parameters, for the purpose of assuring compliance with the permit or applicable requirements as authorized by the Clean Air Act, the Air Pollution Control Act, or the regulations promulgated under the Acts.

(b) Pursuant to 35 P.S. § 4008, no person shall hinder, obstruct, prevent or interfere with the Department or its personnel in the performance of any duty authorized under the Air Pollution Control Act or regulations adopted thereunder including denying the Department access to a source at this facility. Refusal of entry or access may constitute grounds for permit revocation and assessment of criminal and/or civil penalties.

(c) Nothing in this permit condition shall limit the ability of the EPA to inspect or enter the premises of the permittee in accordance with Section 114 or other applicable provisions of the Clean Air Act.

#007 [25 Pa. Code §§ 127.441 & 127.444]**Compliance Requirements.**

(a) The permittee shall comply with the conditions of this operating permit. Noncompliance with this permit constitutes a violation of the Clean Air Act and the Air Pollution Control Act and is grounds for one or more of the following:

**SECTION B. General State Only Requirements**

- (1) Enforcement action
- (2) Permit termination, revocation and reissuance or modification
- (3) Denial of a permit renewal application

(b) A person may not cause or permit the operation of a source which is subject to 25 Pa. Code Article III unless the source(s) and air cleaning devices identified in the application for the plan approval and operating permit and the plan approval issued for the source is operated and maintained in accordance with specifications in the applications and the conditions in the plan approval and operating permit issued by the Department. A person may not cause or permit the operation of an air contamination source subject to 25 Pa. Code Chapter 127 in a manner inconsistent with good operating practices.

(c) For purposes of Sub-condition (b) of this permit condition, the specifications in applications for plan approvals and operating permits are the physical configurations and engineering design details which the Department determines are essential for the permittee's compliance with the applicable requirements in this State-Only permit. Nothing in this sub-condition shall be construed to create an independent affirmative duty upon the permittee to obtain a predetermination from the Department for physical configuration or engineering design detail changes made by the permittee.

#008 [25 Pa. Code § 127.441]**Need to Halt or Reduce Activity Not a Defense.**

It shall not be a defense for the permittee in an enforcement action that it was necessary to halt or reduce the permitted activity in order to maintain compliance with the conditions of this permit.

#009 [25 Pa. Code §§ 127.442(a) & 127.461]**Duty to Provide Information.**

(a) The permittee shall submit reports to the Department containing information the Department may prescribe relative to the operation and maintenance of each source at the facility.

(b) The permittee shall furnish to the Department, in writing, information that the Department may request to determine whether cause exists for modifying, revoking and reissuing, or terminating this permit, or to determine compliance with the permit. Upon request, the permittee shall also furnish to the Department copies of records that the permittee is required to maintain in accordance with this permit.

#010 [25 Pa. Code § 127.461]**Revising an Operating Permit for Cause.**

This operating permit may be terminated, modified, suspended or revoked and reissued if one or more of the following applies:

- (1) The permittee constructs or operates the source subject to the operating permit so that it is in violation of the Air Pollution Control Act, the Clean Air Act, the regulations thereunder, a plan approval, a permit or in a manner that causes air pollution.
- (2) The permittee fails to properly or adequately maintain or repair an air pollution control device or equipment attached to or otherwise made a part of the source.
- (3) The permittee has failed to submit a report required by the operating permit or an applicable regulation.
- (4) The EPA determines that the permit is not in compliance with the Clean Air Act or the regulations thereunder.

#011 [25 Pa. Code §§ 127.450, 127.462, 127.465 & 127.703]**Operating Permit Modifications**

(a) The permittee is authorized to make administrative amendments, minor operating permit modifications and significant operating permit modifications, under this permit, as outlined below:

**SECTION B. General State Only Requirements**

(b) Administrative Amendments. The permittee shall submit the application for administrative operating permit amendments (as defined in 25 Pa. Code § 127.450(a)), according to procedures specified in § 127.450 unless precluded by the Clean Air Act or its regulations.

(c) Minor Operating Permit Modifications. The permittee shall submit the application for minor operating permit modifications (as defined 25 Pa. Code § 121.1) in accordance with 25 Pa. Code § 127.462.

(d) Significant Operating Permit Modifications. The permittee shall submit the application for significant operating permit modifications in accordance with 25 Pa. Code § 127.465.

(e) The applicable fees shall be made payable to "The Commonwealth of Pennsylvania Clean Air Fund" with the permit number clearly indicated and submitted to the respective regional office.

#012 [25 Pa. Code § 127.441]**Severability Clause.**

The provisions of this permit are severable, and if any provision of this permit is determined by a court of competent jurisdiction to be invalid or unenforceable, such a determination will not affect the remaining provisions of this permit.

#013 [25 Pa. Code § 127.449]**De Minimis Emission Increases.**

(a) This permit authorizes de minimis emission increases in accordance with 25 Pa. Code § 127.449 so long as the permittee provides the Department with seven (7) days prior written notice before commencing any de minimis emissions increase. The written notice shall:

(1) Identify and describe the pollutants that will be emitted as a result of the de minimis emissions increase.

(2) Provide emission rates expressed in tons per year and in terms necessary to establish compliance consistent with any applicable requirement.

(b) The Department may disapprove or condition de minimis emission increases at any time.

(c) Except as provided below in (d), the permittee is authorized to make de minimis emission increases (expressed in tons per year) up to the following amounts without the need for a plan approval or prior issuance of a permit modification:

(1) Four tons of carbon monoxide from a single source during the term of the permit and 20 tons of carbon monoxide at the facility during the term of the permit.

(2) One ton of NO_x from a single source during the term of the permit and 5 tons of NO_x at the facility during the term of the permit.

(3) One and six-tenths tons of the oxides of sulfur from a single source during the term of the permit and 8.0 tons of oxides of sulfur at the facility during the term of the permit.

(4) Six-tenths of a ton of PM₁₀ from a single source during the term of the permit and 3.0 tons of PM₁₀ at the facility during the term of the permit. This shall include emissions of a pollutant regulated under Section 112 of the Clean Air Act unless precluded by the Clean Air Act, the regulations thereunder or 25 Pa. Code Article III.

(5) One ton of VOCs from a single source during the term of the permit and 5.0 tons of VOCs at the facility during the term of the permit. This shall include emissions of a pollutant regulated under Section 112 of the Clean Air Act unless precluded by the Clean Air Act, the regulations thereunder or 25 Pa. Code Article III.

(6) Other sources and classes of sources determined to be of minor significance by the Department.

(d) In accordance with § 127.14, the permittee is authorized to install the following minor sources without the need for a plan approval or permit modification:

**SECTION B. General State Only Requirements**

- (1) Air conditioning or ventilation systems not designed to remove pollutants generated or released from other sources.
 - (2) Combustion units rated at 2,500,000 or less Btu per hour of heat input.
 - (3) Combustion units with a rated capacity of less than 10,000,000 Btu per hour heat input fueled by natural gas supplied by a public utility or by commercial fuel oils which are No. 2 or lighter, viscosity less than or equal to 5.82 c St, and which meet the sulfur content requirements of 25 Pa. Code §123.22 (relating to combustion units). For purposes of this permit, commercial fuel oil shall be virgin oil which has no reprocessed, recycled or waste material added.
 - (4) Space heaters which heat by direct heat transfer.
 - (5) Laboratory equipment used exclusively for chemical or physical analysis.
 - (6) Other sources and classes of sources determined to be of minor significance by the Department.
- (e) This permit does not authorize de minimis emission increases if the emissions increase would cause one or more of the following:
- (1) Increase the emissions of a pollutant regulated under Section 112 of the Clean Air Act except as authorized in Subparagraphs (c)(4) and (5) of this permit condition.
 - (2) Subject the facility to the prevention of significant deterioration requirements in 25 Pa. Code Chapter 127, Subchapter D and/or the new source review requirements in Subchapter E.
 - (3) Violate any applicable requirement of this permit, the Air Pollution Control Act, the Clean Air Act, or the regulations promulgated under either of the acts.
- (f) Emissions authorized under this permit condition shall be included in the monitoring, recordkeeping and reporting requirements of this permit.
- (g) Except for de minimis emission increases, installation of minor sources made pursuant to this permit condition and Plan Approval Exemptions under 25 Pa. Code § 127.14 (relating to exemptions), the permittee is prohibited from making changes or engaging in activities that are not specifically authorized under this permit without first applying for a plan approval. In accordance with § 127.14(b), a plan approval is not required for the construction, modification, reactivation, or installation of the sources creating the de minimis emissions increase.
- (h) The permittee may not meet de minimis emission threshold levels by offsetting emission increases or decreases at the same source.

#014 [25 Pa. Code § 127.3]**Operational Flexibility.**

The permittee is authorized to make changes within the facility in accordance with the regulatory provisions outlined in 25 Pa. Code § 127.3 (relating to operational flexibility) to implement the operational flexibility requirements provisions authorized under Section 6.1(i) of the Air Pollution Control Act and the operational flexibility terms and conditions of this permit. The provisions in 25 Pa. Code Chapter 127 which implement the operational flexibility requirements include the following:

- (1) Section 127.14 (relating to exemptions)
- (2) Section 127.447 (relating to alternative operating scenarios)
- (3) Section 127.448 (relating to emissions trading at facilities with Federally enforceable emissions caps)
- (4) Section 127.449 (relating to de minimis emission increases)
- (5) Section 127.450 (relating to administrative operating permit amendments)

**SECTION B. General State Only Requirements**

(6) Section 127.462 (relating to minor operating permit modifications)

(7) Subchapter H (relating to general plan approvals and general operating permits)

#015 [25 Pa. Code § 127.11]**Reactivation**

(a) The permittee may not reactivate a source that has been out of operation or production for at least one year unless the reactivation is conducted in accordance with a plan approval granted by the Department or in accordance with reactivation and maintenance plans developed and approved by the Department in accordance with 25 Pa. Code § 127.11a(a).

(b) A source which has been out of operation or production for more than five (5) years but less than 10 years may be reactivated and will not be considered a new source if the permittee satisfies the conditions specified in 25 Pa. Code § 127.11a(b).

#016 [25 Pa. Code § 127.36]**Health Risk-based Emission Standards and Operating Practice Requirements.**

(a) When needed to protect public health, welfare and the environment from emissions of hazardous air pollutants from new and existing sources, the permittee shall comply with the health risk-based emission standards or operating practice requirements imposed by the Department, except as precluded by §§ 6.6(d)(2) and (3) of the Air Pollution Control Act [35 P.S. § 4006.6(d)(2) and (3)].

(b) A person challenging a performance or emission standard established by the Department has the burden to demonstrate that performance or emission standard does not meet the requirements of Section 112 of the Clean Air Act.

#017 [25 Pa. Code § 121.9]**Circumvention.**

No person may permit the use of a device, stack height which exceeds good engineering practice stack height, dispersion technique or other technique which, without resulting in reduction of the total amount of air contaminants emitted, conceals or dilutes an emission of air contaminants which would otherwise be in violation of 25 Pa. Code Article III, except that with prior approval of the Department, the device or technique may be used for control of malodors.

#018 [25 Pa. Code §§ 127.402(d) & 127.442]**Reporting Requirements.**

(a) The permittee shall comply with the applicable reporting requirements of the Clean Air Act, the regulations thereunder, the Air Pollution Control Act and 25 Pa. Code Article III including Chapters 127, 135 and 139.

(b) The permittee shall submit reports to the Department containing information the Department may prescribe relative to the operation and maintenance of any air contamination source.

(c) Reports, test data, monitoring data, notifications and requests for renewal of the permit shall be submitted to the:

Regional Air Program Manager
PA Department of Environmental Protection
(At the address given in the permit transmittal letter, or otherwise notified)

(d) Any records or information including applications, forms, or reports submitted pursuant to this permit condition shall contain a certification by a responsible official as to truth, accuracy and completeness. The certifications submitted under this permit shall require a responsible official of the facility to certify that based on information and belief formed after reasonable inquiry, the statements and information in the documents are true, accurate and complete.

(e) Any records, reports or information submitted to the Department shall be available to the public except for such

**SECTION B. General State Only Requirements**

records, reports or information which meet the confidentiality requirements of § 4013.2 of the Air Pollution Control Act and §§ 112(d) and 114(c) of the Clean Air Act. The permittee may not request a claim of confidentiality for any emissions data generated for the facility.

#019 [25 Pa. Code §§ 127.441(c) & 135.5]**Sampling, Testing and Monitoring Procedures.**

(a) The permittee shall comply with the monitoring, recordkeeping or reporting requirements of 25 Pa. Code Chapter 139 and the other applicable requirements of 25 Pa. Code Article III and additional requirements related to monitoring, reporting and recordkeeping required by the Clean Air Act and the regulations thereunder including the Compliance Assurance Monitoring requirements of 40 CFR Part 64, where applicable.

(b) Unless alternative methodology is required by the Clean Air Act and regulations adopted thereunder, sampling, testing and monitoring required by or used by the permittee to demonstrate compliance with any applicable regulation or permit condition shall be conducted in accordance with the requirements of 25 Pa. Code Chapter 139.

#020 [25 Pa. Code §§ 127.441(c) and 135.5]**Recordkeeping.**

(a) The permittee shall maintain and make available, upon request by the Department, the following records of monitored information:

- (1) The date, place (as defined in the permit) and time of sampling or measurements.
- (2) The dates the analyses were performed.
- (3) The company or entity that performed the analyses.
- (4) The analytical techniques or methods used.
- (5) The results of the analyses.
- (6) The operating conditions as existing at the time of sampling or measurement.

(b) The permittee shall retain records of any required monitoring data and supporting information for at least five (5) years from the date of the monitoring, sample, measurement, report or application. Supporting information includes the calibration data and maintenance records and original strip-chart recordings for continuous monitoring instrumentation, and copies of reports required by the permit.

(c) The permittee shall maintain and make available to the Department upon request, records including computerized records that may be necessary to comply with the reporting, recordkeeping and emission statement requirements in 25 Pa. Code Chapter 135 (relating to reporting of sources). In accordance with 25 Pa. Code Chapter 135, § 135.5, such records may include records of production, fuel usage, maintenance of production or pollution control equipment or other information determined by the Department to be necessary for identification and quantification of potential and actual air contaminant emissions.

#021 [25 Pa. Code § 127.441(a)]**Property Rights.**

This permit does not convey any property rights of any sort, or any exclusive privileges.

#022 [25 Pa. Code § 127.447]**Alternative Operating Scenarios.**

The permittee is authorized to make changes at the facility to implement alternative operating scenarios identified in this permit in accordance with 25 Pa. Code § 127.447.

**SECTION B. General State Only Requirements****#023 [25 Pa. Code §135.3]****Reporting**

(a) If the facility is a Synthetic Minor Facility, the permittee shall submit by March 1 of each year an annual emissions report for the preceding calendar year. The report shall include information for all active previously reported sources, new sources which were first operated during the preceding calendar year, and sources modified during the same period which were not previously reported. All air emissions from the facility should be estimated and reported.

(b) A source owner or operator of a Synthetic Minor Facility may request an extension of time from the Department for the filing of an annual emissions report, and the Department may grant the extension for reasonable cause.

#024 [25 Pa. Code §135.4]**Report Format**

If applicable, the emissions reports shall contain sufficient information to enable the Department to complete its emission inventory. Emissions reports shall be made by the source owner or operator in a format specified by the Department.

**SECTION C. Site Level Requirements****I. RESTRICTIONS.****Emission Restriction(s).****# 001 [25 Pa. Code §123.1]****Prohibition of certain fugitive emissions**

No person may permit the emission into the outdoor atmosphere of fugitive air contaminants from a source other than the following:

- (1) Construction or demolition of buildings or structures.
- (2) Grading, paving and maintenance of roads and streets.
- (3) Use of roads and streets. Emissions from material in or on trucks, railroad cars and other vehicular equipment are not considered as emissions from use of roads and streets.
- (4) Clearing of land.
- (5) Stockpiling of materials.
- (6) Open burning operations.
- (7) Blasting in open pit mines. Emissions from drilling are not considered as emissions from blasting.
- (8) Sources and classes of sources other than those identified above, for which the permittee has obtained a determination from the Department that fugitive emissions from the source, after appropriate control, meet the following requirements:
 - (a) The emissions are of minor significance with respect to causing air pollution.
 - (b) The emissions are not preventing or interfering with the attainment or maintenance of any ambient air quality standard.

002 [25 Pa. Code §123.2]**Fugitive particulate matter**

No person may permit fugitive particulate matter to be emitted into the outdoor atmosphere from a source specified in (1) through (8) of condition #001 herein if the emissions are visible at the point the emissions pass outside the person's property.

003 [25 Pa. Code §123.41]**Limitations**

No person may permit the emission into the outdoor atmosphere of visible air contaminants in such a manner that the opacity of the emission is either of the following:

- (1) Equal to or greater than 20% for a period or periods aggregating more than three minutes in any 1 hour.
- (2) Equal to or greater than 60% at any time.

004 [25 Pa. Code §123.42]**Exceptions**

The emission limitations of 25 Pa Code Section 123.41 shall not apply when:

- (1) The presence of uncombined water is the only reason for failure of the emission to meet the limitations;
- (2) The emission results from the operation of equipment used solely to train and test persons in observing the opacity of visible emissions;
- (3) The emissions results from sources specified in 25 Pa Code Section 123.1(a)(1)-(9).

**SECTION C. Site Level Requirements****# 005 [25 Pa. Code §127.441]****Operating permit terms and conditions.**

[Additional authority for this permit condition is derived from the permittee requesting this condition]

- (a) The total volatile organic compounds emitted facility wide shall not equal or exceed 50 tons in any 12 consecutive month period.
- (b) The total emission of any combination of hazardous air pollutants emitted facility wide shall not equal or exceed 25 tons in any 12 consecutive month period.
- (c) The total emissions of any single hazardous air pollutant emitted facility wide shall not equal or exceed 10 tons in any 12 consecutive month period.

II. TESTING REQUIREMENTS.**# 006 [25 Pa. Code §127.441]****Operating permit terms and conditions.**

[Additional authority for this permit condition is derived from 25 Pa. Code Section 127.511]

The permittee shall conduct tests which determine through Method 24 of 40 CFR Part 60 and 25 Pa. Code Chapter 139 the volatile organic compound content of all coatings, solvents and adhesives used at this facility,

OR

the permittee shall maintain documentation (certified product data sheets) from the supplier/manufacture which specify the volatile organic compound content of all coatings, solvents and adhesives used at this facility.

007 [25 Pa. Code §127.513]**Compliance certification.**

The Department specifically reserves the right to require testing of a source at any time if it has the reason to believe that the emission limitations set forth in any condition of this permit are being exceeded.

008 [25 Pa. Code §139.1]**Sampling facilities.**

Upon the request of the Department, the permittee shall provide adequate sampling ports, safe sampling platforms and adequate utilities for the performance by the Department of tests on a source. The Department will set forth, in the request, the time period in which the facilities shall be provided as well as the specifications for such facilities.

009 [25 Pa. Code §139.11]**General requirements.**

- (a) As specified in 25 Pa. Code Section 139.11(1), performance tests shall be conducted while the source is operating at maximum routine operating conditions or under such other conditions, within the capacity of the equipment, as may be requested by the Department.
- (b) As specified in 25 Pa. Code Section 139.11(2), the Department will consider test results for approval where sufficient information is provided to verify the source conditions existing at the time of the test and where adequate data is available to show the manner in which the test was conducted. Information submitted to the Department shall include, as a minimum, all of the following:
 - (1) A thorough source description, including a description of any air cleaning devices and the flue.
 - (2) Process conditions, for example, the charging rate of raw materials or the rate of production of final product, boiler pressure, oven temperature and other conditions which may effect emissions from the process.

**SECTION C. Site Level Requirements**

- (3) The location of sampling ports.
- (4) Effluent characteristics, including velocity, temperature, moisture content, gas density (percentage CO, CO₂, O₂ and N₂), static and barometric pressures.
- (5) Sample collection techniques employed, including procedures used, equipment descriptions and data to verify that isokinetic sampling for particulate matter collection occurred and that acceptable test conditions were met.
- (6) Laboratory procedures and results.
- (7) Calculated results.

III. MONITORING REQUIREMENTS.**# 010 [25 Pa. Code §123.43]****Measuring techniques**

Visible emissions may be measured using either of the following:

- (1) A device approved by the Department and maintained to provide accurate opacity measurements.
- (2) Observers, trained and certified, to measure plume opacity with the naked eye or with the aid of any devices approved by the Department.

011 [25 Pa. Code §127.441]**Operating permit terms and conditions.**

[Additional authority for this permit condition is derived from 25 Pa. Code Section 127.511]

(a) The permittee shall conduct a monthly inspection of the facility during daylight hours while the facility is operating, to detect visible emissions, visible fugitive emissions and malodors. Monthly inspections are necessary to determine:

- the presence of visible emissions.
- the presence of visible fugitive emissions.
- the presence of malodors beyond the facility's property boundaries.

(b) All detected visible emissions, visible fugitive emissions or malodors that have the potential to exceed applicable limits shall be reported to the manager of the facility.

IV. RECORDKEEPING REQUIREMENTS.**# 012 [25 Pa. Code §127.441]****Operating permit terms and conditions.**

[Additional authority for this permit condition is derived from 25 Pa. Code Section 127.511]

The permittee shall keep records of tests conducted through Method 24 of 40 CFR Part 60 and 25 Pa. Code Chapter 139 which determines the volatile organic compound content for all coatings, solvents and adhesives used at this facility,

OR

the permittee shall keep documentation (certified product data sheets) from the supplier/manufacturer which specifies the volatile organic compound content of all coatings, solvents and adhesives used at this facility.

The above records shall be retained for a minimum of five years and shall be made available to the Department upon request.

**SECTION C. Site Level Requirements****# 013 [25 Pa. Code §127.441]****Operating permit terms and conditions.**

[Additional authority for this permit condition is derived from 25 Pa. Code Section 127.511]

(a) The permittee shall maintain a logbook of the facility inspections performed. The logbook shall include the name of the company representative performing each inspection, the date and time of each inspection, whether any visible emissions or visible fugitive emissions were observed, whether any odors were detected at the facility boundaries, whether any observed visible emissions, visible fugitive emissions or odor emissions were determined to be in excess of the applicable regulatory limits and the name of the manager informed if a potential exceedance is observed. The permittee shall also record any and all corrective action(s) taken to abate each recorded deviation or prevent future occurrences.

(b) All records generated pursuant to this condition shall be retained for a minimum of five years and shall be made available to the Department upon request.

014 [25 Pa. Code §127.441]**Operating permit terms and conditions.**

(a) The permittee shall keep records of the supporting calculations used to verify compliance with the facility-wide volatile organic compounds and hazardous air pollutant emission limitations.

(b) All records generated pursuant to this condition shall be retained for a minimum of five years and shall be made available to the Department upon request.

015 [25 Pa. Code §135.5]**Recordkeeping**

The permittee shall maintain such records including computerized records as may be necessary to comply with 25 Pa. Code Sections 135.3. These may include records of production, fuel usage, maintenance of production or pollution control equipment or other information determined by the Department to be necessary for identification and quantification of potential and actual air contaminant emissions.

V. REPORTING REQUIREMENTS.**# 016 [25 Pa. Code §127.441]****Operating permit terms and conditions.**

[Additional authority for this permit condition is also derived from 25 Pa. Code Section 135.3]

(a) The permittee shall submit by March 1 of each year an annual Air Information Management System (AIMS) emission report for the preceding calendar year. The report shall include information for all previously reported sources, new sources, which were first operated during the preceding calendar year, and sources modified during the same period which were not previously reported.

(b) A source owner may request an extension of time from the Department for the filing of an annual Air Information Management System (AIMS) emission report, and the Department may grant the extension for reasonable cause.

017 [25 Pa. Code §127.441]**Operating permit terms and conditions.**

Upon request by the Department, the permittee shall submit all requested reports in accordance with the Department's suggested format.

018 [25 Pa. Code §127.442]**Reporting requirements.**

(a) The permittee shall report malfunctions, emergencies or incidents of excess emissions to the Department. A malfunction is any sudden, infrequent, and not reasonably preventable failure of air pollution control equipment, process equipment, or a process to operate in a normal or usual manner. An emergency is any situation arising from sudden and reasonably unforeseeable events beyond the control of the owner or operator of a facility which requires immediate corrective action to restore normal operation and which causes the emission source to exceed emissions, due to unavoidable increases in emissions attributable to the situation. An emergency shall not include situations caused by improperly designed equipment, lack of preventive maintenance, careless or improper operation, or operator error.

**SECTION C. Site Level Requirements**

(b) When the malfunction, emergency or incident of excess emissions poses an imminent danger to the public health, safety, welfare, or environment, it shall be reported to the Department and the County Emergency Management Agency by telephone within one (1) hour after the discovery of the malfunction, emergency or incident of excess emissions. The owner or operator shall submit a written or emailed report of instances of such malfunctions, emergencies or incidents of excess emissions to the Department within three (3) business days of the telephone report.

(c) The report shall describe the following:

1. name, permit or authorization number, and location of the facility,
2. nature and cause of the malfunction, emergency or incident,
3. date and time when the malfunction, emergency or incident was first observed,
4. expected duration of excess emissions,
5. estimated rate of emissions,
6. corrective actions or preventative measures taken.

(d) Any malfunction, emergency or incident of excess emissions that is not subject to the notice requirements of paragraph (b) of this condition shall be reported to the Department by telephone within 24 hours (or by 4:00 PM of the next business day, whichever is later) of discovery and in writing or by e-mail within five (5) business days of discovery. The report shall contain the same information required by paragraph (c), and any permit specific malfunction reporting requirements.

(e) During an emergency an owner or operator may continue to operate the source at their discretion provided they submit justification for continued operation of a source during the emergency and follow all the notification and reporting requirements in accordance with paragraphs (b)-(d), as applicable, including any permit specific malfunction reporting requirements.

(f) Reports regarding malfunctions, emergencies or incidents of excess emissions shall be submitted to the appropriate DEP Regional Office Air Program Manager.

(g) Any emissions resulted from malfunction or emergency are to be reported in the annual emissions inventory report, if the annual emissions inventory report is required by permit or authorization.

019 [25 Pa. Code §135.3]**Reporting**

(a) A person who owns or operates a source to which 25 Pa. Code Chapter 135 applies, and who has previously been advised by the Department to submit an annual Air Information Management Systems (AIMS) report, shall submit by March 1 of each year an annual AIMS report for the preceding calendar year. The report shall include information for all previously reported sources, new sources which were first operated during the preceding calendar year and sources modified during the same period which were not previously reported.

(b) A person who receives initial notification by the Department that an annual AIMS report is necessary shall submit an initial annual AIMS report within 60 days after receiving the notification or by March 1 of the year following the year for which the report is required, whichever is later.

(c) A source owner or operator may request an extension of time from the Department for the filing of a source report, and the Department may grant the extension for reasonable cause.

VI. WORK PRACTICE REQUIREMENTS.**# 020 [25 Pa. Code §123.1]****Prohibition of certain fugitive emissions**

For any source specified in 25 Pa. Code Section 123.1 subsection(s) (a)(1)-(7) or (a)(9), the permittee shall take all reasonable actions to prevent particulate matter from becoming airborne. These actions shall include, but not be limited to, the following:

- (1) Use, where possible, of water or chemicals for control of dust in the demolition of buildings or structures, construction operations, the grading of roads, or the clearing of land,

**SECTION C. Site Level Requirements**

- (2) Application of asphalt, oil, or suitable chemicals on dirt roads, material stockpiles, and other surfaces which may give rise to airborne dusts,
- (3) Paving and maintenance of roadways,
- (4) Prompt removal of earth or other material from paved streets onto which earth or other material has been transported by trucking or earth moving equipment, erosion by water, or other means.

021 [25 Pa. Code §127.441]**Operating permit terms and conditions.**

[Additional authority for this permit condition is derived from the permittee not triggering 40 CFR Part 63 Subpart HHHHHH]

The permittee shall not perform the spray application of coatings containing compounds of chromium (Cr), lead (Pb), manganese (Mn), nickel (Ni), or cadmium (Cd).

VII. ADDITIONAL REQUIREMENTS.**# 022 [25 Pa. Code §121.7]****Prohibition of air pollution.**

No person may permit air pollution as that term is defined in the Pennsylvania Air Pollution Control Act (35 P.S. §§ 4001-4015).

023 [25 Pa. Code §123.31]**Limitations**

No person may permit the emission into the outdoor atmosphere of any malodorous air contaminants from any source in such a manner that the malodors are detectable outside the property of the person on whose land the source is being operated.

024 [25 Pa. Code §129.14]**Open burning operations**

No person may permit the open burning of material at this Title V facility unless in accordance with 25 Pa. Code Section 129.14.

VIII. COMPLIANCE CERTIFICATION.

No additional compliance certifications exist except as provided in other sections of this permit including Section B (relating to State Only General Requirements).

IX. COMPLIANCE SCHEDULE.

No compliance milestones exist.

**SECTION D. Source Level Requirements**

Source ID: 031

Source Name: 6 SPACE HEATERS < 2.5 MMBTU/HR

Source Capacity/Throughput:

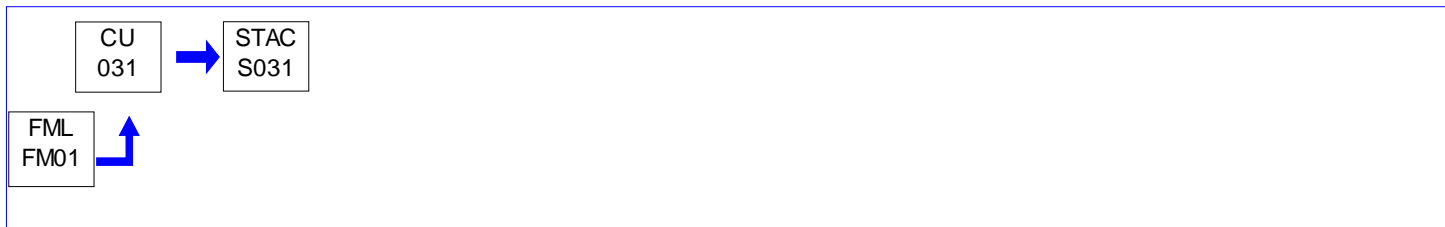
**I. RESTRICTIONS.****Emission Restriction(s).**

001 [25 Pa. Code §123.22]

Combustion units

No person may permit the emission into the outdoor atmosphere of sulfur oxides, expressed as SO₂, from any combustion unit incorporated in Source ID 031 in excess of the rate of 4 pounds per million BTU of heat input over any 1-hour period.

002 [25 Pa. Code §127.441]

Operating permit terms and conditions.

[Additional authority for this permit condition is derived from 25 Pa. Code Section 129.91]

The potential volatile organic compound emissions from Source IDs 031, 032 and the natural gas-fired burners associated with Source ID P104 shall not exceed 3 pounds per hour, 15 pounds per day or 2.7 tons in any 12 consecutive month period. Should any of these limitations ever be exceeded, a detailed RACT analysis which meets the criteria specified in 25 Pa. Code Section 129.92 shall be submitted to the Department for each of the respective sources.

Fuel Restriction(s).

003 [25 Pa. Code §127.441]

Operating permit terms and conditions.

The combustion units incorporated in Source ID 031 shall only be fired on natural gas.

II. TESTING REQUIREMENTS.

No additional testing requirements exist except as provided in other sections of this permit including Section B (State Only General Requirements).

III. MONITORING REQUIREMENTS.

No additional monitoring requirements exist except as provided in other sections of this permit including Section B (State Only General Requirements).

IV. RECORDKEEPING REQUIREMENTS.

004 [25 Pa. Code §127.441]

Operating permit terms and conditions.

[Additional authority for this permit condition is derived from 25 Pa. Code Sections 129.95 and 127.511]

The permittee shall keep records of the supporting calculations used to verify compliance with the potential to emit volatile organic compounds limitations for Source IDs 031, 032 and P104. These records shall include, but are not limited to, the total amount of natural gas consumed each month in Source IDs 031, 032 and P104.

These records shall be retained for a minimum of five years and shall be made available to the Department upon request.

**SECTION D. Source Level Requirements****V. REPORTING REQUIREMENTS.**

No additional reporting requirements exist except as provided in other sections of this permit including Section B (State Only General Requirements).

VI. WORK PRACTICE REQUIREMENTS.

No additional work practice requirements exist except as provided in other sections of this permit including Section B (State Only General Requirements).

VII. ADDITIONAL REQUIREMENTS.

005 [25 Pa. Code §127.441]

Operating permit terms and conditions.

Source ID 031 consists of the following natural gas-fired combustion units:

- (a) One 0.1 MMBtu/hr natural-gas fired heater at the end of Production Line 1
- (b) Five 0.1 MMBtu/hr natural-gas fired heaters in Fabrication shop

**SECTION D. Source Level Requirements**

Source ID: 032

Source Name: 2 SPACE HEATERS >2.5 MMBTU/HR

Source Capacity/Throughput:

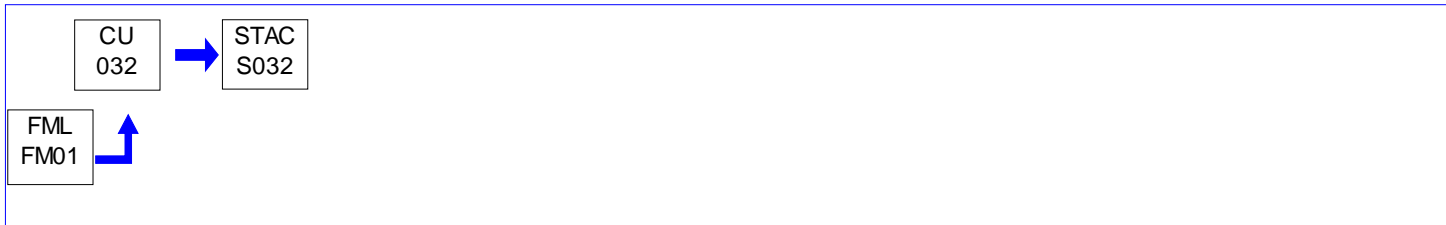
**I. RESTRICTIONS.****Emission Restriction(s).****# 001 [25 Pa. Code §123.11]****Combustion units**

No person may permit the emission of particulate matter from any combustion unit incorporated in Source ID 032 into the outdoor atmosphere in excess of 0.40 pounds per million Btu of heat input.

002 [25 Pa. Code §123.22]**Combustion units**

No person may permit the emission into the outdoor atmosphere of sulfur oxides, expressed as SO₂, from any combustion unit incorporated in Source ID 032 in excess of the rate of 4 pounds per million BTU of heat input over any 1-hour period.

003 [25 Pa. Code §127.441]**Operating permit terms and conditions.**

[Additional authority for this permit condition is derived from 25 Pa. Code Section 129.91]

The potential volatile organic compound emissions from Source IDs 031, 032 and the natural gas-fired burners associated with Source ID P104 shall not exceed 3 pounds per hour, 15 pounds per day or 2.7 tons in any 12 consecutive month period. Should any of these limitations ever be exceeded, a detailed RACT analysis which meets the criteria specified in 25 Pa. Code Section 129.92 shall be submitted to the Department for each of the respective sources.

Fuel Restriction(s).**# 004 [25 Pa. Code §127.441]****Operating permit terms and conditions.**

The combustion units incorporated in Source ID 032 shall only be fired on natural gas.

II. TESTING REQUIREMENTS.

No additional testing requirements exist except as provided in other sections of this permit including Section B (State Only General Requirements).

III. MONITORING REQUIREMENTS.

No additional monitoring requirements exist except as provided in other sections of this permit including Section B (State Only General Requirements).

IV. RECORDKEEPING REQUIREMENTS.**# 005 [25 Pa. Code §127.441]****Operating permit terms and conditions.**

[Additional authority for this permit condition is derived from 25 Pa. Code Sections 129.95 and 127.511]

The permittee shall keep records of the supporting calculations used to verify compliance with the potential to emit volatile organic compounds limitations for Source IDs 031, 032 and P104. These records shall include, but are not limited to, the

**SECTION D. Source Level Requirements**

total amount of natural gas consumed each month in Source IDs 031, 032 and P104.

These records shall be retained for a minimum of five years and shall be made available to the Department upon request.

V. REPORTING REQUIREMENTS.

No additional reporting requirements exist except as provided in other sections of this permit including Section B (State Only General Requirements).

VI. WORK PRACTICE REQUIREMENTS.

No additional work practice requirements exist except as provided in other sections of this permit including Section B (State Only General Requirements).

VII. ADDITIONAL REQUIREMENTS.

006 [25 Pa. Code §127.441]

Operating permit terms and conditions.

Source ID 032 consists of two natural gas-fired space heaters each rated at 4.95 million Btu per hour. One located at the end of Production Line 1 and one located at the end of Production Line 2.

**SECTION D. Source Level Requirements**

Source ID: P101

Source Name: CHASSIS PAINT BOOTH (LINE 1)

Source Capacity/Throughput:

Conditions for this source occur in the following groups: 129.52D

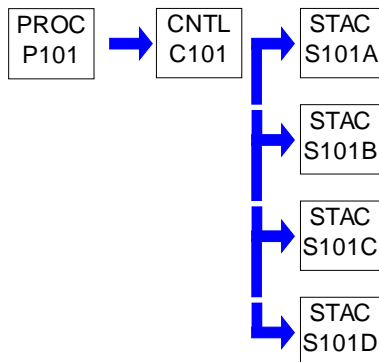
**I. RESTRICTIONS.****Emission Restriction(s).****# 001 [25 Pa. Code §123.13]****Processes**

No person may permit the emission of particulate matter from Control Device ID C101, associated with Source ID P101, into the outdoor atmosphere in excess of 0.04 grains per dry standard cubic foot of effluent gas volume.

002 [25 Pa. Code §127.441]**Operating permit terms and conditions.**

[Additional authority for this permit condition is derived from the permittee requesting this limitation]

(a) The following limitation applies to all of the coatings used in Source P101 and Source P102:

(1) The weight of volatile organic compounds per volume of coating shall not exceed 2.8 pounds of volatile organic compounds per gallon of coating (less exemptibles).

003 [25 Pa. Code §127.441]**Operating permit terms and conditions.**

[Additional authority for this permit condition is derived from the permittee requesting this limitation]

(a) The following limitation applies to all of the coatings used in Source P101 and Source P102:

(1) The total weight of hazardous air pollutants per volume of coating shall not exceed 1.3 pounds of hazardous air pollutants per gallon of coating.

004 [25 Pa. Code §127.441]**Operating permit terms and conditions.**

[Additional authority for this permit condition is derived from the permittee requesting this limitation]

(a) The following limitation applies to all of the coatings used in Source P101 and Source P102:

(1) The weight of any individual hazardous air pollutant per volume of coating shall not exceed 0.29 pounds of hazardous air pollutant per gallon of coating.

005 [25 Pa. Code §127.441]**Operating permit terms and conditions.**

[Additional authority for this permit condition is derived from the permittee requesting this limitation]

**SECTION D. Source Level Requirements**

(a) The total volatile organic compound emissions from Sources P101 and P102 shall not exceed 45.89 tons in any 12 consecutive month period, combined (i.e., total volatile organic compound emissions from Source P101 plus the total volatile organic compound emissions from Source P102 shall not exceed 45.89 tons in any 12 consecutive month period).

006 [25 Pa. Code §127.441]

Operating permit terms and conditions.

[Additional authority for this permit condition is derived from the permittee requesting this limitation]

(a) The total combined hazardous air pollutant emissions from Sources P101 and P102 shall not exceed 24.86 tons in any 12 consecutive month period, combined (i.e., total combined hazardous air pollutant emissions from Source P101 plus the total combined hazardous air pollutant emissions from Source P102 shall not exceed 24.86 tons in any 12 consecutive month period).

007 [25 Pa. Code §127.441]

Operating permit terms and conditions.

[Additional authority for this permit condition is derived from the permittee requesting this limitation]

(a) The total emissions of any individual hazardous air pollutant from Sources P101 and P102 shall not exceed 5.56 tons in any 12 consecutive month period, combined (i.e., total emissions of any individual hazardous air pollutant from Source P101 plus the total emissions of any individual hazardous air pollutant from Source P102 shall not exceed 5.56 tons in any 12 consecutive month period).

008 [25 Pa. Code §129.52]

Surface coating processes

The weight of volatile organic compounds per volume of coating solids shall not exceed 6.67 pounds of volatile organic compounds per gallon coating solids as specified in 25 Pa. Code Section 129.52 Table I under Miscellaneous metal parts and products.

II. TESTING REQUIREMENTS.

No additional testing requirements exist except as provided in other sections of this permit including Section B (State Only General Requirements) and/or Section E (Source Group Restrictions).

III. MONITORING REQUIREMENTS.

009 [25 Pa. Code §127.441]

Operating permit terms and conditions.

[Additional authority for this permit condition is derived from the Request for Determination authorized on January 14, 2021]

The permittee shall visually inspect the sidewall filters and inner floor filters every day prior to operating any booth incorporated in Source P101.

IV. RECORDKEEPING REQUIREMENTS.

010 [25 Pa. Code §127.441]

Operating permit terms and conditions.

(a) The permittee shall keep comprehensive and accurate records of the volatile organic compound emissions and hazardous air pollutant emissions from Source P101 and Source P102, on a monthly basis, to demonstrate compliance with the emission limits for these sources.

(b) All records generated pursuant to this condition shall be retained for a minimum of five years and shall be made available to the Department upon request.

**SECTION D. Source Level Requirements****# 011 [25 Pa. Code §127.441]****Operating permit terms and conditions.**

[Additional authority for this permit condition is derived from 40 CFR Part 64 Section 64.9]

General recordkeeping requirements. (1) The owner or operator shall comply with the recordkeeping requirements specified in §70.6(a)(3)(ii) of this chapter. The owner or operator shall maintain records of monitoring data, monitor performance data, corrective actions taken, any written quality improvement plan required pursuant to §64.8 and any activities undertaken to implement a quality improvement plan, and other supporting information required to be maintained under this part (such as data used to document the adequacy of monitoring, or records of monitoring maintenance or corrective actions).

(2) Instead of paper records, the owner or operator may maintain records on alternative media, such as microfilm, computer files, magnetic tape disks, or microfiche, provided that the use of such alternative media allows for expeditious inspection and review, and does not conflict with other applicable recordkeeping requirements.

012 [25 Pa. Code §127.441]**Operating permit terms and conditions.**

[Additional authority for this permit condition is derived from 25 Pa. Code Sections 129.52 and 127.511]

(a) The permittee shall, at a minimum, keep daily records of:

(1) The following parameters for each coating, thinner, additive, cleaning material, and other components as supplied for use in Source ID P101:

(i) The coating, thinner, additive, cleaning material, and other component name and identification number.

(ii) The volume used.

(iii) The mix ratio

(iv) The density or specific gravity

(v) The weight percent of total volatiles, water, solids and exempt solvents.

(vi) The volume percent of solvents.

(vii) The volume fraction of coating solids.

(2) The volatile organic compounds content (pounds of volatile organic compounds per gallon of solids) of each coating, thinner and other component as supplied for use in Source ID P101.

(3) The volatile organic compounds content (pounds of volatile organic compounds per gallon of solids) of each as applied coating used in Source ID P101.

(4) The volatile organic compounds content (pounds of volatile organic compounds per gallon of coating (less exemptibles)) of each coating used in Source ID P101.

(5) The organic hazardous air pollutant content (pounds of organic hazardous air pollutant per gallon of solids) of each coating, thinner, additive, cleaning material, and other component as supplied for use in Source ID P101.

(6) The organic hazardous air pollutant content (pounds of organic hazardous air pollutant per gallon of solids) of each as applied coating used in Source ID P101.

(7) The hazardous air pollutant content (pounds of hazardous air pollutant per gallon of coating) of each coating used in

**SECTION D. Source Level Requirements**

Source ID P101.

(8) Current material safety data sheets and/or certified product data sheets.

(9) Demonstration that the coatings did not contain any compounds of chromium (Cr), lead (Pb), manganese (Mn), nickel (Ni), or cadmium (Cd).

(b) All records generated pursuant to this condition shall be retained for a minimum of five years and shall be made available to the Department upon request.

013 [25 Pa. Code §127.441]

Operating permit terms and conditions.

[Additional authority for this permit condition is derived from the Request for Determination authorized on January 14, 2021]

(a) The permittee shall keep comprehensive and accurate records of each visual inspection of each filter associated with the booths incorporated in Source P101. The records shall include the initials of the person performing the inspection as well as the date and time of each inspection. Additionally, the permittee shall keep comprehensive and accurate records of the date for each filter replacement.

(b) All records generated pursuant to this condition shall be retained for a minimum of five years and shall be made available to the department upon request.

V. REPORTING REQUIREMENTS.

014 [25 Pa. Code §127.441]

Operating permit terms and conditions.

[Additional authority for this permit condition is derived from 40 CFR Part 64 Section 64.9]

(a) General reporting requirements. (1) On and after the date specified in §64.7(a) by which the owner or operator must use monitoring that meets the requirements of this part, the owner or operator shall submit monitoring reports to the permitting authority in accordance with §70.6(a)(3)(iii) of this chapter.

(2) A report for monitoring under this part shall include, at a minimum, the information required under §70.6(a)(3)(iii) of this chapter and the following information, as applicable:

(i) Summary information on the number, duration and cause (including unknown cause, if applicable) of excursions or exceedances, as applicable, and the corrective actions taken;

(ii) Summary information on the number, duration and cause (including unknown cause, if applicable) for monitor downtime incidents (other than downtime associated with zero and span or other daily calibration checks, if applicable); and

(iii) A description of the actions taken to implement a QIP during the reporting period as specified in §64.8. Upon completion of a QIP, the owner or operator shall include in the next summary report documentation that the implementation of the plan has been completed and reduced the likelihood of similar levels of excursions or exceedances occurring.

015 [25 Pa. Code §127.441]

Operating permit terms and conditions.

(a) The permittee shall submit semi-annual reports which include the supporting calculations utilized to verify compliance with the volatile organic compound and hazardous air pollutant emission limitations for Source P101 and Source P102 in any 12 consecutive month period.

(b) The semi-annual reports shall be submitted to the Department by no later than September 1 (for July 1 of the previous year through June 30 of the concurrent year) and March 1 (for January 1 through December 31 of the previous year).

**SECTION D. Source Level Requirements****VI. WORK PRACTICE REQUIREMENTS.****# 016 [25 Pa. Code §127.441]****Operating permit terms and conditions.**

[Additional authority for this permit condition is derived from 40 CFR Part 64 Section 64.7]

Upon detecting an excursion, as defined in 40 CFR Section 64.1, of the Compliance Assurance Monitoring (CAM) routine filter changes established herein, the permittee shall restore operation of Source ID P101 and/or Control Device C101 to its normal or usual manner of operation as expeditiously as practicable in accordance with good air pollution control practices for minimizing emissions. The response shall include minimizing the period of any startup, shutdown or malfunction and taking any necessary corrective actions to restore normal operation and prevent the likely recurrence of the cause of the excursion.

017 [25 Pa. Code §127.441]**Operating permit terms and conditions.**

[Additional authority for this permit condition is derived from the Request for Determination authorized on January 14, 2021]

The permittee shall replace the sidewall filters when visually spent or once every other week, whichever occurs first. The booths incorporated in Source P101 shall not be operated until the spent filters are replaced with new filters.

018 [25 Pa. Code §127.441]**Operating permit terms and conditions.**

[Additional authority for this permit condition is derived from the Request for Determination authorized on January 14, 2021]

The permittee shall replace the inner floor filters when visually spent or once per month, whichever occurs first. The booths incorporated in Source P101 shall not be operated until the spent filters are replaced with new filters.

VII. ADDITIONAL REQUIREMENTS.**# 019 [25 Pa. Code §127.441]****Operating permit terms and conditions.**

[Additional authority for this permit condition is derived from 40 CFR Part 64 Section 64.8]

(a) The permittee shall develop and implement a quality improvement plan (QIP) as expeditiously as practicable if any of the following occurs:

(1) for properly and accurately collected data, accumulated excursions exceed 5% duration of the operational time in the reporting period,

(2) six (6) excursions occur in a six-month reporting period, or

(3) the Department determines after review of all reported information that the permittee has not responded acceptably to an excursion.

(b) The permittee shall follow the provisions of 40 CFR Section 64.8 if a QIP is required.

020 [25 Pa. Code §127.441]**Operating permit terms and conditions.**

Source ID P101 is a "Line 1" chassis paint system consisting of a booth used to prime and a booth used to topcoat truck trailer chassis. The air contaminant emissions from Source ID P101 shall be controlled by particulate filters (Control Device ID C101).

021 [25 Pa. Code §127.441]**Operating permit terms and conditions.**

Source ID P101 is subject to 25 Pa. Code Section 129.52. The permittee shall comply with all applicable requirements specified in 25 Pa. Code Section 129.52.

**SECTION D. Source Level Requirements****# 022 [25 Pa. Code §129.52]****Surface coating processes**

The VOC content of the as applied coating(s) used in Source ID P101, expressed in units of weight of VOC per volume of coating solids, shall be calculated as follows:

$$\text{VOC} = (\text{Wo})(\text{Dc})/\text{Vn}$$

Where:

VOC = VOC content in lb VOC/gal of coating solids

Wo = Weight percent of VOC (Wv-Ww-Wex)

Wv = Weight percent of total volatiles (100%-weight percent solids)

Ww = Weight percent of water

Wex = Weight percent of exempt solvent(s)

Dc = Density of coating, lb/gal, at 25 degrees C

Vn = Volume percent of solids of the as applied coating

023 [40 CFR Part 64 Compliance Assurance Monitoring for Major Stationary Sources §40 CFR 64.2]**Sections of PART 64****Applicability**

Source ID P101 is subject to 40 CFR Part 64 Compliance Assurance Monitoring (CAM). The permittee shall comply with the requirements, as specified in 40 CFR Sections 64.1 through 64.10. In addition, the permittee shall follow the provisions of the submitted CAM Plan and supplemental information.

**SECTION D. Source Level Requirements**

Source ID: P102

Source Name: DEVILBISS SPRAY BOOTH (LINE 2)

Source Capacity/Throughput:

Conditions for this source occur in the following groups: 129.52D

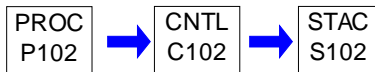
**I. RESTRICTIONS.****Emission Restriction(s).****# 001 [25 Pa. Code §123.13]****Processes**

No person may permit the emission of particulate matter from Control Device ID C102, associated with Source ID P102, into the outdoor atmosphere in excess of 0.04 grains per dry standard cubic foot of effluent gas volume.

002 [25 Pa. Code §127.441]**Operating permit terms and conditions.**

[Additional authority for this permit condition is derived from 25 Pa. Code Sections 127.1 and 127.12]

The volatile organic compound emissions from Source ID P102 shall not exceed 30 tons in any 12 consecutive month period. This includes the volatile organic compound emissions resulting from the use of cleanup solvents in Source ID P102.

003 [25 Pa. Code §127.441]**Operating permit terms and conditions.**

[Additional authority for this permit condition is derived from the permittee requesting this limitation]

(a) The following limitation applies to all of the coatings used in Source P101 and Source P102:

(1) The weight of volatile organic compounds per volume of coating shall not exceed 2.8 pounds of volatile organic compounds per gallon of coating (less exemptibles).

004 [25 Pa. Code §127.441]**Operating permit terms and conditions.**

[Additional authority for this permit condition is derived from the permittee requesting this limitation]

(a) The following limitation applies to all of the coatings used in Source P101 and Source P102:

(1) The total weight of hazardous air pollutants per volume of coating shall not exceed 1.3 pounds of hazardous air pollutants per gallon of coating.

005 [25 Pa. Code §127.441]**Operating permit terms and conditions.**

[Additional authority for this permit condition is derived from the permittee requesting this limitation]

(a) The following limitation applies to all of the coatings used in Source P101 and Source P102:

(1) The weight of any individual hazardous air pollutant per volume of coating shall not exceed 0.29 pounds of hazardous air pollutant per gallon of coating.

006 [25 Pa. Code §127.441]**Operating permit terms and conditions.**

[Additional authority for this permit condition is derived from the permittee requesting this limitation]

(a) The total volatile organic compound emissions from Sources P101 and P102 shall not exceed 45.89 tons in any 12 consecutive month period, combined (i.e., total volatile organic compound emissions from Source P101 plus the total

**SECTION D. Source Level Requirements**

volatile organic compound emissions from Source P102 shall not exceed 45.89 tons in any 12 consecutive month period).

007 [25 Pa. Code §127.441]**Operating permit terms and conditions.**

[Additional authority for this permit condition is derived from the permittee requesting this limitation]

(a) The total combined hazardous air pollutant emissions from Sources P101 and P102 shall not exceed 24.86 tons in any 12 consecutive month period, combined (i.e., total combined hazardous air pollutant emissions from Source P101 plus the total combined hazardous air pollutant emissions from Source P102 shall not exceed 24.86 tons in any 12 consecutive month period).

008 [25 Pa. Code §127.441]**Operating permit terms and conditions.**

[Additional authority for this permit condition is derived from the permittee requesting this limitation]

(a) The total emissions of any individual hazardous air pollutant from Sources P101 and P102 shall not exceed 5.56 tons in any 12 consecutive month period, combined (i.e., total emissions of any individual hazardous air pollutant from Source P101 plus the total emissions of any individual hazardous air pollutant from Source P102 shall not exceed 5.56 tons in any 12 consecutive month period).

Throughput Restriction(s).**# 009 [25 Pa. Code §127.441]****Operating permit terms and conditions.**

[Additional authority for this permit condition is derived from 25 Pa. Code Sections 127.1 and 127.12]

Under no circumstances shall any coatings containing methylene chloride, 1,1,1 trichloroethane (methyl chloroform) or formaldehyde be used in Source ID P102.

010 [25 Pa. Code §127.441]**Operating permit terms and conditions.**

[Additional authority for this permit condition is derived from 25 Pa. Code Sections 127.1 and 127.12]

(a) The coatings used in Source ID P102 shall contain no more than 2.8 pounds of volatile organic compounds per gallon of coating (minus water) as mixed for application except for the following:

(b) Customer-specified coating materials which cannot be reformulated to meet the 2.8 pound per gallon volatile organic compound content limitation, may be used in this surface coating operation so long as they meet the applicable requirements of 25 Pa. Code Section 129.52, and so long as the total volatile organic compound emissions resulting from the use of such coating materials do not exceed 3 tons in any 12 consecutive month period.

011 [25 Pa. Code §129.52]**Surface coating processes**

The weight of volatile organic compounds per volume of coating solids shall not exceed 6.67 pounds of volatile organic compounds per gallon coating solids as specified in 25 Pa. Code Section 129.52 Table I under Miscellaneous metal parts and products.

II. TESTING REQUIREMENTS.

No additional testing requirements exist except as provided in other sections of this permit including Section B (State Only General Requirements) and/or Section E (Source Group Restrictions).

**SECTION D. Source Level Requirements****III. MONITORING REQUIREMENTS.****# 012 [25 Pa. Code §127.441]****Operating permit terms and conditions.**

[Additional authority for this permit condition is derived from 40 CFR Part 64 Section 64.6]

The particulate filters associated with the booth incorporated into Source ID P102 shall be equipped with instrumentation to continuously monitor the differential pressure across the respective filter. This instrumentation shall be operated on any occasion the respective control device is operating.

IV. RECORDKEEPING REQUIREMENTS.**# 013 [25 Pa. Code §127.441]****Operating permit terms and conditions.**

[Additional authority for this permit condition is derived from 40 CFR Part 64 Section 64.9]

General recordkeeping requirements. (1) The owner or operator shall comply with the recordkeeping requirements specified in §70.6(a)(3)(ii) of this chapter. The owner or operator shall maintain records of monitoring data, monitor performance data, corrective actions taken, any written quality improvement plan required pursuant to §64.8 and any activities undertaken to implement a quality improvement plan, and other supporting information required to be maintained under this part (such as data used to document the adequacy of monitoring, or records of monitoring maintenance or corrective actions).

(2) Instead of paper records, the owner or operator may maintain records on alternative media, such as microfilm, computer files, magnetic tape disks, or microfiche, provided that the use of such alternative media allows for expeditious inspection and review, and does not conflict with other applicable recordkeeping requirements.

014 [25 Pa. Code §127.441]**Operating permit terms and conditions.**

[Additional authority for this permit condition is derived from 25 Pa. Code Sections 129.52 and 127.511]

(a) The permittee shall, at a minimum, keep daily records of:

(1) The following parameters for each coating, thinner, additive, cleaning material, and other components as supplied for use in Source ID P102:

(i) The coating, thinner, additive, cleaning material, and other component name and identification number.

(ii) The volume used.

(iii) The mix ratio

(iv) The density or specific gravity

(v) The weight percent of total volatiles, water, solids and exempt solvents.

(vi) The volume percent of solvents.

(vii) The volume fraction of coating solids.

(2) The volatile organic compounds content (pounds of volatile organic compounds per gallon of solids) of each coating, thinner and other component as supplied for use in Source ID P102.

(3) The volatile organic compounds content (pounds of volatile organic compounds per gallon of solids) of each as applied coating used in Source ID P102.

**SECTION D. Source Level Requirements**

(4) The volatile organic compounds content (pounds of volatile organic compounds per gallon of coating (less exemptibles)) of each coating used in Source ID P102.

(5) The organic hazardous air pollutant content (pounds of organic hazardous air pollutant per gallon of solids) of each coating, thinner, additive, cleaning material, and other component as supplied for use in Source ID P102.

(6) The organic hazardous air pollutant content (pounds of organic hazardous air pollutant per gallon of solids) of each as applied coating used in Source ID P102.

(7) The hazardous air pollutant content (pounds of hazardous air pollutant per gallon of coating) of each coating used in Source ID P102.

(8) Current material safety data sheets and/or certified product data sheets.

(9) Demonstration that the coatings did not contain any compounds of chromium (Cr), lead (Pb), manganese (Mn), nickel (Ni), or cadmium (Cd).

(b) All records generated pursuant to this condition shall be retained for a minimum of five years and shall be made available to the Department upon request.

015 [25 Pa. Code §127.441]**Operating permit terms and conditions.**

[Additional authority for this permit condition is derived from 25 Pa. Code Section 127.511]

(a) The permittee shall keep records of the supporting calculations used to verify compliance with the 30 ton volatile organic compounds emission limitation in any 12 consecutive month period. These records shall include, but are not limited to, the identity and amount of all cleanup solvents used each month and the amount of all waste cleanup solvents shipped offsite each month in liquid form for disposal associated with Source ID P102.

(b) Additionally, the permittee shall keep records of the supporting calculations used to verify compliance with the 3 ton volatile organic compounds emission limitation in any 12 consecutive month period when using coatings that do not meet the volatile organic compounds content limitation of 2.8 pounds per gallon of coating and the permittee shall keep records of all instances when using coatings in Source ID P102 that do not meet the subject volatile organic compounds content limitation.

(c) All records generated pursuant to this condition shall be retained for a minimum of five years and shall be made available to the Department upon request.

016 [25 Pa. Code §127.441]**Operating permit terms and conditions.**

[Additional authority for this permit condition is derived from 40 CFR Part 64 Section 64.6]

The permittee shall keep comprehensive and accurate logbooks of the pressure drop across the particulate filters associated with the booth incorporated into Source ID P102 at least once per shift while the booth is in operation. In addition to the pressure drop, the logbooks shall also include the date and time the reading was observed and the initials of the observer.

017 [25 Pa. Code §127.441]**Operating permit terms and conditions.**

(a) The permittee shall keep comprehensive and accurate records of the volatile organic compound emissions and hazardous air pollutant emissions from Source P101 and Source P102, on a monthly basis, to demonstrate compliance with the emission limits for these sources.

(b) All records generated pursuant to this condition shall be retained for a minimum of five years and shall be made available to the Department upon request.

**SECTION D. Source Level Requirements****V. REPORTING REQUIREMENTS.****# 018 [25 Pa. Code §127.441]****Operating permit terms and conditions.**

[Additional authority for this permit condition is derived from 25 Pa. Code Section 127.511]

(a) The permittee shall submit semi-annual reports of the supporting calculations verifying compliance with the 30 ton volatile organic compounds emission limitation in any 12 consecutive month period. The reports shall include, but are not limited to, the identity and monthly amount of all cleanup solvents used and the monthly amount of all waste cleanup solvents shipped offsite in liquid form for disposal associated with Source ID P102.

(b) Each semi-annual report shall be submitted to the Department no later than March 1 (for the immediately-preceding July 1 through December 31 six consecutive month period) and September 1 (for the immediately-preceding January 1 through June 30 six consecutive month period).

019 [25 Pa. Code §127.441]**Operating permit terms and conditions.**

[Additional authority for this permit condition is derived from 40 CFR Part 64 Section 64.9]

(a) General reporting requirements. (1) On and after the date specified in §64.7(a) by which the owner or operator must use monitoring that meets the requirements of this part, the owner or operator shall submit monitoring reports to the permitting authority in accordance with §70.6(a)(3)(iii) of this chapter.

(2) A report for monitoring under this part shall include, at a minimum, the information required under §70.6(a)(3)(iii) of this chapter and the following information, as applicable:

- (i) Summary information on the number, duration and cause (including unknown cause, if applicable) of excursions or exceedances, as applicable, and the corrective actions taken;
- (ii) Summary information on the number, duration and cause (including unknown cause, if applicable) for monitor downtime incidents (other than downtime associated with zero and span or other daily calibration checks, if applicable); and
- (iii) A description of the actions taken to implement a QIP during the reporting period as specified in §64.8. Upon completion of a QIP, the owner or operator shall include in the next summary report documentation that the implementation of the plan has been completed and reduced the likelihood of similar levels of excursions or exceedances occurring.

020 [25 Pa. Code §127.441]**Operating permit terms and conditions.**

(a) The permittee shall submit semi-annual reports which include the supporting calculations utilized to verify compliance with the volatile organic compound and hazardous air pollutant emission limitations for Source P101 and Source P102 in any 12 consecutive month period.

(b) The semi-annual reports shall be submitted to the Department by no later than September 1 (for July 1 of the previous year through June 30 of the concurrent year) and March 1 (for January 1 through December 31 of the previous year).

VI. WORK PRACTICE REQUIREMENTS.**# 021 [25 Pa. Code §127.441]****Operating permit terms and conditions.**

[Additional authority for this permit condition is derived from 25 Pa. Code Sections 127.1 and 127.12]

All solvent used for the cleaning of paint spray guns and lines shall be flushed into an enclosed container. Under no circumstances shall volatile organic compound-containing cleaning solvent be sprayed through a spray gun into the atmosphere. All containers of volatile organic compound-containing cleaning solvents or mixtures of paint waste and cleaning solvents shall be kept closed except when material is being added to, or removed from, the containers. Under no circumstances shall volatile organic compound-containing cleaning solvents or mixtures of paint waste and cleaning solvents be disposed of via methods, which promote the evaporative loss of volatile organic compounds into the atmosphere.

022 [25 Pa. Code §127.441]**Operating permit terms and conditions.**

**SECTION D. Source Level Requirements**

[Additional authority for this permit condition is derived from 25 Pa. Code Sections 127.1 and 127.12]

All coatings applied in Source ID P102 shall be applied with either airless or air assisted airless spray guns. Conventional air-atomized air spray guns shall not be used under any circumstances.

023 [25 Pa. Code §127.441]

Operating permit terms and conditions.

[Additional authority for this permit condition is derived from 40 CFR Part 64 Section 64.6]

The pressure differential range, indicating normal operation, is greater than 0.05" of water up to and including 0.6" of water. Any reading outside this range is considered an excursion, as defined in 40 CFR Section 64.1.

024 [25 Pa. Code §127.441]

Operating permit terms and conditions.

[Additional authority for this permit condition is derived from 40 CFR Part 64 Section 64.7]

Upon detecting an excursion, as defined in 40 CFR Section 64.1, of the Compliance Assurance Monitoring (CAM) pressure differential range established herein, the permittee shall restore operation of Source ID P102 and/or Control Device C102 to its normal or usual manner of operation as expeditiously as practicable in accordance with good air pollution control practices for minimizing emissions. The response shall include minimizing the period of any startup, shutdown or malfunction and taking any necessary corrective actions to restore normal operation and prevent the likely recurrence of the cause of the excursion.

VII. ADDITIONAL REQUIREMENTS.

025 [25 Pa. Code §127.441]

Operating permit terms and conditions.

[Additional authority for this permit condition is derived from 25 Pa. Code Sections 127.1 and 127.12]

Source ID P102 is a "Line 2" surface coating operation incorporating a DeVilbiss Series 3000 horizontal-flow spray booth. The air contaminant emissions from Source ID P102 shall be controlled by 98.5% efficient (or better) particulate filters (Control Device ID C102).

026 [25 Pa. Code §127.441]

Operating permit terms and conditions.

Source ID P102 is subject to 25 Pa. Code Section 129.52. The permittee shall comply with all applicable requirements specified in 25 Pa. Code Section 129.52.

027 [25 Pa. Code §127.441]

Operating permit terms and conditions.

[Additional authority for this permit condition is derived from 40 CFR Part 64 Section 64.8]

(a) The permittee shall develop and implement a quality improvement plan (QIP) as expeditiously as practicable if any of the following occurs:

- (1) for properly and accurately collected data, accumulated excursions exceed 5% duration of the operational time in the reporting period,
- (2) six (6) excursions occur in a six-month reporting period, or
- (3) the Department determines after review of all reported information that the permittee has not responded acceptably to an excursion.

(b) The permittee shall follow the provisions of 40 CFR Section 64.8 if a QIP is required.

028 [25 Pa. Code §129.52]

Surface coating processes

Pursuant to 25 Pa. Code Section 129.52(b)(1)(i), the VOC content of the as applied coating(s) used in Source ID P102, expressed in units of weight of VOC per volume of coating solids, shall be calculated as follows:

**SECTION D. Source Level Requirements**

$$\text{VOC} = (\text{Wo})(\text{Dc})/\text{Vn}$$

Where:

VOC = VOC content in lb VOC/gal of coating solids

Wo = Weight percent of VOC ($Wv - Ww - Wex$)

Wv = Weight percent of total volatiles (100%-weight percent solids)

Ww = Weight percent of water

Wex = Weight percent of exempt solvent(s)

Dc = Density of coating, lb/gal, at 25 degrees C

Vn = Volume percent of solids of the as applied coating

029 [40 CFR Part 64 Compliance Assurance Monitoring for Major Stationary Sources §40 CFR 64.2]

Sections of PART 64**Applicability**

Source ID P102 is subject to 40 CFR Part 64 Compliance Assurance Monitoring (CAM). The permittee shall comply with the requirements, as specified in 40 CFR Sections 64.1 through 64.10. In addition, the permittee shall follow the provisions of the submitted CAM Plan and supplemental information.

**SECTION D. Source Level Requirements**

Source ID: P103

Source Name: EQUIPMENT CLEANUP ACTIVITIES

Source Capacity/Throughput:

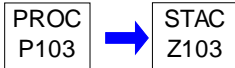
**I. RESTRICTIONS.****Emission Restriction(s).****# 001 [25 Pa. Code §127.441]****Operating permit terms and conditions.**

[Additional authority for this permit condition is derived from 25 Pa. Code Section 129.91]

The total combined volatile organic compound emissions from Source ID P103 shall not exceed 3 pounds per hour, 15 pounds per day or 2.7 tons in any 12 consecutive month period. Should any of these limitations ever be exceeded a detailed RACT analysis which meets the criteria specified in 25 Pa. Code Section 129.92 must be submitted to the Department for Source ID P103.

II. TESTING REQUIREMENTS.

No additional testing requirements exist except as provided in other sections of this permit including Section B (State Only General Requirements).

III. MONITORING REQUIREMENTS.

No additional monitoring requirements exist except as provided in other sections of this permit including Section B (State Only General Requirements).

IV. RECORDKEEPING REQUIREMENTS.**# 002 [25 Pa. Code §127.441]****Operating permit terms and conditions.**

[Additional authority for this permit condition is derived from 25 Pa. Code Sections 127.511 and 129.95]

(a) The permittee shall keep records of the supporting calculations used to verify compliance with the potential to emit volatile organic compounds limitations for Source ID P103. These records shall include, but are not limited to:

- the date, identity and total quantity of each cleanup solvent purchased each month
- the date and total quantity of waste solvent disposed of in liquid form each month
- the identity and total amount of fresh cleanup solvent remaining on-hand (i.e., inventory) on the last day of each month (specify month)

(b) These records shall be retained for a minimum of five years and shall be made available to the Department upon request.

V. REPORTING REQUIREMENTS.**# 003 [25 Pa. Code §127.441]****Operating permit terms and conditions.**

[Additional authority for this permit condition is derived from 25 Pa. Code Section 127.511]

(a) The permittee shall submit annual reports of the supporting calculations verifying compliance with the potential to emit volatile organic compounds limitations for Source ID P103. The reports shall include, but are not limited to:

**SECTION D. Source Level Requirements**

- the identity and total quantity of each cleanup solvent purchased each month during the quarter
- the total quantity of waste solvent disposed of in liquid form each month during the quarter
- the identity and total amount of fresh cleanup solvent remaining on-hand (i.e., inventory) on the last day of the month during the quarter

(b) The annual reports shall be submitted to the Department no later than March 1 for the previous 12 consecutive month period.

VI. WORK PRACTICE REQUIREMENTS.

No additional work practice requirements exist except as provided in other sections of this permit including Section B (State Only General Requirements).

VII. ADDITIONAL REQUIREMENTS.

004 [25 Pa. Code §127.441]

Operating permit terms and conditions.

Source ID P103 consists of surface coating equipment cleanup activities (including all parts washers existing on site prior to October, 1997) - spray gun cleaning, spray line flushing, etc.

**SECTION D. Source Level Requirements**

Source ID: P104

Source Name: LINE 1 CURING OVEN

Source Capacity/Throughput: 1.100 MMBTU/HR

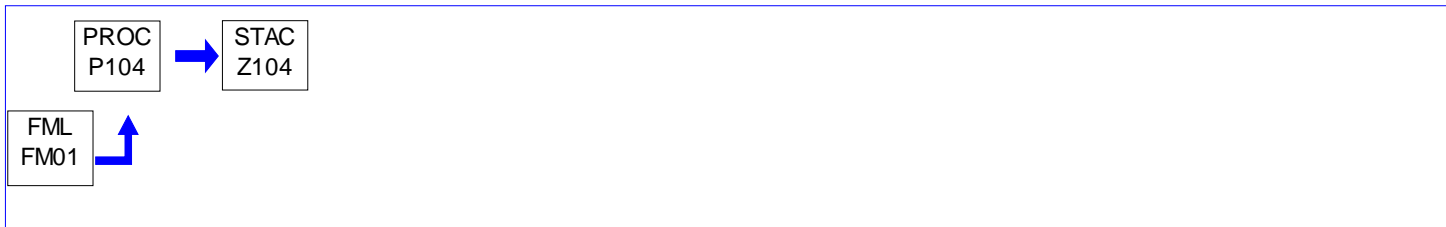
**I. RESTRICTIONS.****Emission Restriction(s).**

001 [25 Pa. Code §123.21]

General

No person may permit the emission into the outdoor atmosphere of sulfur oxides, expressed as SO₂, from Source ID P104 in a manner such that the concentration in the effluent gas exceeds 500 parts per million, by volume, dry basis.

002 [25 Pa. Code §127.441]

Operating permit terms and conditions.

[Additional authority for this permit condition is derived from 25 Pa. Code Section 129.91]

The potential volatile organic compound emissions from Source IDs 031, 032 and the natural gas-fired burners associated with Source ID P104 shall not exceed 3 pounds per hour, 15 pounds per day or 2.7 tons in any 12 consecutive month period. Should any of these limitations ever be exceeded, a detailed RACT analysis which meets the criteria specified in 25 Pa. Code Section 129.92 shall be submitted to the Department for each of the respective sources.

Fuel Restriction(s).

003 [25 Pa. Code §127.441]

Operating permit terms and conditions.

The burners associated with Source ID P104 shall only be fired on natural gas.

II. TESTING REQUIREMENTS.

No additional testing requirements exist except as provided in other sections of this permit including Section B (State Only General Requirements).

III. MONITORING REQUIREMENTS.

No additional monitoring requirements exist except as provided in other sections of this permit including Section B (State Only General Requirements).

IV. RECORDKEEPING REQUIREMENTS.

004 [25 Pa. Code §127.441]

Operating permit terms and conditions.

[Additional authority for this permit condition is derived from 25 Pa. Code Sections 129.95 and 127.511]

The permittee shall keep records of the supporting calculations used to verify compliance with the potential to emit volatile organic compounds limitations for Source IDs 031, 032 and P104. These records shall include, but are not limited to, the total amount of natural gas consumed each month in Source IDs 031, 032 and P104.

These records shall be retained for a minimum of five years and shall be made available to the Department upon request.

**SECTION D. Source Level Requirements****V. REPORTING REQUIREMENTS.**

No additional reporting requirements exist except as provided in other sections of this permit including Section B (State Only General Requirements).

VI. WORK PRACTICE REQUIREMENTS.

No additional work practice requirements exist except as provided in other sections of this permit including Section B (State Only General Requirements).

VII. ADDITIONAL REQUIREMENTS.

005 [25 Pa. Code §127.441]

Operating permit terms and conditions.

Source ID P104 is an 1.1 million Btu per hour natural gas-fired "Line 1" curing oven.

**SECTION D. Source Level Requirements**

Source ID: P105

Source Name: SPRAY GUNS WASHER

Source Capacity/Throughput:

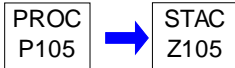
**I. RESTRICTIONS.****Emission Restriction(s).****# 001 [25 Pa. Code §127.441]****Operating permit terms and conditions.**

[Additional authority for this permit condition is derived from 25 Pa. Code Section 127.14]

The total combined volatile organic compound emissions from Source ID P105 shall not exceed 1 ton in any 12 consecutive month period.

II. TESTING REQUIREMENTS.

No additional testing requirements exist except as provided in other sections of this permit including Section B (State Only General Requirements).

III. MONITORING REQUIREMENTS.

No additional monitoring requirements exist except as provided in other sections of this permit including Section B (State Only General Requirements).

IV. RECORDKEEPING REQUIREMENTS.**# 002 [25 Pa. Code §127.441]****Operating permit terms and conditions.**

[Additional authority for this permit condition is derived from 25 Pa. Code Section 127.511]

(a) The permittee shall keep records of the supporting calculations used to verify compliance with the 1 ton volatile organic compounds emission limitation in any 12 consecutive month period for Source ID P105. These records shall include, but are not limited to, the identity and amount of all gun cleaning solvent(s) used each month and the amount of all waste solvent(s) shipped offsite each month in liquid form for disposal.

(b) These records shall be retained for a minimum of five years and shall be made available to the Department upon request.

V. REPORTING REQUIREMENTS.**# 003 [25 Pa. Code §127.441]****Operating permit terms and conditions.**

[Additional authority for this permit condition is derived from 25 Pa. Code Section 127.511]

(a) The permittee shall submit annual reports of the supporting calculations verifying compliance with the 1 ton volatile organic compounds emission limitation in any 12 consecutive month period for Source ID P105. These reports shall include, but are not limited to, the identity and monthly amounts of all gun cleaning solvent(s) used and the monthly amounts of all waste solvent(s) shipped offsite in liquid form for disposal.

(b) The annual reports shall be submitted to the Department no later than March 1 for the previous 12 consecutive month period.

**SECTION D. Source Level Requirements****VI. WORK PRACTICE REQUIREMENTS.**

No additional work practice requirements exist except as provided in other sections of this permit including Section B (State Only General Requirements).

VII. ADDITIONAL REQUIREMENTS.

004 [25 Pa. Code §127.441]

Operating permit terms and conditions.

Source ID P105 is a Graco spray guns washer.

**SECTION D. Source Level Requirements**

Source ID: P106

Source Name: SHOT BLAST BOOTHS

Source Capacity/Throughput:

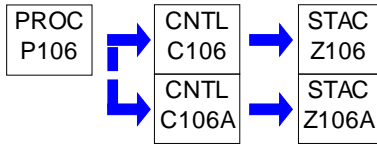
**I. RESTRICTIONS.**

No additional requirements exist except as provided in other sections of this permit including Section B (State Only General Requirements).

II. TESTING REQUIREMENTS.

No additional testing requirements exist except as provided in other sections of this permit including Section B (State Only General Requirements).

III. MONITORING REQUIREMENTS.

No additional monitoring requirements exist except as provided in other sections of this permit including Section B (State Only General Requirements).

IV. RECORDKEEPING REQUIREMENTS.

No additional record keeping requirements exist except as provided in other sections of this permit including Section B (State Only General Requirements).

V. REPORTING REQUIREMENTS.

No additional reporting requirements exist except as provided in other sections of this permit including Section B (State Only General Requirements).

VI. WORK PRACTICE REQUIREMENTS.

No additional work practice requirements exist except as provided in other sections of this permit including Section B (State Only General Requirements).

VII. ADDITIONAL REQUIREMENTS.**# 001 [25 Pa. Code §127.441]****Operating permit terms and conditions.**

Source P106 consists of a Hoffmann/DFT-2-12 "Line 1" shot blast booth and a Hoffmann/DFT4-32 "Line 2" shot blast booth. The air contaminant emissions from each of these sources shall each be controlled by a fabric collector (Control Devices C106 and C106A) which shall not be exhausted to the outdoor atmosphere.

**SECTION E. Source Group Restrictions.**

Group Name: 129.52D

Group Description: 129.52d

Sources included in this group

ID	Name
P101	CHASSIS PAINT BOOTH (LINE 1)
P102	DEVILBISS SPRAY BOOTH (LINE 2)

I. RESTRICTIONS.**Emission Restriction(s).****# 001 [25 Pa. Code §129.52d]****Control of VOC emissions from miscellaneous metal parts surface coating processes, miscellaneous plastic parts surf:**

The weight of volatile organic compounds per gallon of coating as applied, excluding water and exempt compounds, shall not exceed 2.8 pounds as specified in 25 Pa. Code Section 129.52d Table I under Metal Parts and Products Surface Coatings.

II. TESTING REQUIREMENTS.

No additional testing requirements exist except as provided in other sections of this permit including Section B (State Only General Requirements).

III. MONITORING REQUIREMENTS.

No additional monitoring requirements exist except as provided in other sections of this permit including Section B (State Only General Requirements).

IV. RECORDKEEPING REQUIREMENTS.**# 002 [25 Pa. Code §129.52d]****Control of VOC emissions from miscellaneous metal parts surface coating processes, miscellaneous plastic parts surface coating processes and pleasure craft surface coatings.**

(f) Recordkeeping and reporting requirements.

(1) The owner or operator of a miscellaneous metal part coating unit or miscellaneous plastic part coating unit, or both, subject to subsection (a)(1) shall maintain monthly records sufficient to demonstrate compliance with this section. The records must include the following information:

(i) The following parameters for each coating, thinner, component and cleaning solvent as supplied:

(A) Name and identification number of the coating, thinner, other component or cleaning solvent.

(B) Volume used.

(C) Mix ratio.

(D) Density or specific gravity.

(E) Weight percent of total volatiles, water, solids and exempt solvents.

(F) Volume percent of total volatiles, water and exempt solvents for the applicable table of limits in Tables I—V.

(G) Volume percent of solids for the applicable table of limits in Tables VI—IX.

(ii) The VOC content of each coating, thinner, other component and cleaning solvent as supplied.

(iii) The VOC content of each as applied coating or cleaning solvent.

(iv) The calculations performed for each applicable requirement under subsections (d) and (e).

**SECTION E. Source Group Restrictions.**

(v) The information required in a plan approval issued under subsection (e)(2).

(2) An owner or operator subject to subsection (a)(2), or otherwise claiming an exemption or exception in this section, shall maintain records sufficient to verify the applicability of subsection (a)(2), the exemption or exception. Records maintained for compliance demonstrations may include purchase, use, production and other records.

(3) The records shall be maintained onsite for 2 years, unless a longer period is required by an order, plan approval or operating permit issued under Chapter 127 (relating to construction, modification, reactivation and operation of sources).

(4) The records shall be submitted to the Department in an acceptable format upon receipt of a written request from the Department.

V. REPORTING REQUIREMENTS.

No additional reporting requirements exist except as provided in other sections of this permit including Section B (State Only General Requirements).

VI. WORK PRACTICE REQUIREMENTS.**# 003 [25 Pa. Code §129.52d]****Control of VOC emissions from miscellaneous metal parts surface coating processes, miscellaneous plastic parts surface coating processes and pleasure craft surface coatings.**

(g) Coating application methods. A person subject to subsection (a)(1) may not cause or permit the emission into the outdoor atmosphere of VOCs from a miscellaneous metal part coating unit or miscellaneous plastic part coating unit, or both, unless the coatings are applied using one or more of the following coating application methods:

- (1) Electrostatic coating.
- (2) Flow coating.
- (3) Dip coating, including electrodeposition.
- (4) Roll coating.
- (5) High volume-low pressure (HVLP) spray coating.
- (6) Airless spray coating.
- (7) Air-assisted airless spray coating.
- (8) Other coating application method if approved in writing by the Department prior to use.

(i) The coating application method must be capable of achieving a transfer efficiency equivalent to or better than that achieved by HVLP spray coating.

(ii) The owner or operator shall submit the request for approval to the Department in writing.

004 [25 Pa. Code §129.52d]**Control of VOC emissions from miscellaneous metal parts surface coating processes, miscellaneous plastic parts surface coating processes and pleasure craft surface coatings.**

(i) Work practice requirements for coating-related activities. The owner or operator of a miscellaneous metal part coating unit or miscellaneous plastic part coating unit, or both, subject to subsection (a)(1) shall comply with the following work practices for coating-related activities:

- (1) Store all VOC-containing coatings, thinners or coating-related waste materials in closed containers.
- (2) Ensure that mixing and storage containers used for VOC-containing coatings, thinners or coating-related waste materials are kept closed at all times, except when depositing or removing these coatings, thinners or waste materials.

**SECTION E. Source Group Restrictions.**

(3) Minimize spills of VOC-containing coatings, thinners or coating-related waste materials and clean up spills immediately.

(4) Convey VOC-containing coatings, thinners or coating-related waste materials from one location to another in closed containers or pipes.

005 [25 Pa. Code §129.52d]**Control of VOC emissions from miscellaneous metal parts surface coating processes, miscellaneous plastic parts surface coating processes and pleasure craft surface coatings.**

(j) Work practice requirements for cleaning materials. The owner or operator of a miscellaneous metal part coating unit or miscellaneous plastic part coating unit subject to subsection (a)(1) shall comply with the following work practices for cleaning materials:

(1) Store all VOC-containing cleaning materials and used shop towels in closed containers.

(2) Ensure that mixing vessels and storage containers used for VOC-containing cleaning materials are kept closed at all times except when depositing or removing these materials.

(3) Minimize spills of VOC-containing cleaning materials and clean up spills immediately.

(4) Convey VOC-containing cleaning materials from one location to another in closed containers or pipes.

(5) Minimize VOC emissions from cleaning of application, storage, mixing or conveying equipment by ensuring that equipment cleaning is performed without atomizing the cleaning solvent and all spent solvent is captured in closed containers.

006 [25 Pa. Code §129.52d]**Control of VOC emissions from miscellaneous metal parts surface coating processes, miscellaneous plastic parts surface coating processes and pleasure craft surface coatings.**

(k) Measurements and calculations. To determine the properties of a coating or component used in a miscellaneous metal parts surface coating process or miscellaneous plastic parts surface coating process, measurements and calculations shall be performed according to one or more of the following:

(1) EPA Reference Method 24, Determination of Volatile Matter Content, Water Content, Density, Volume Solids, and Weight Solids of Surface Coatings, found at 40 CFR Part 60, Subpart D, Appendix A, including updates and revisions.

(2) Manufacturer's formulation data.

(3) Sampling and testing done in accordance with the procedures and test methods specified in Chapter 139.

(4) Other test method demonstrated to provide results that are acceptable for purposes of determining compliance with this section if prior approval is obtained in writing from the Department.

(5) Add-on air pollution control devices shall be equipped with the applicable monitoring equipment according to manufacturers' specifications. The monitoring equipment shall be installed, calibrated, operated and maintained according to manufacturers' specifications at all times the add-on air pollution control device is in use.

(6) EPA calculations information in the following:

(i) A Guideline for Surface Coating Calculations, EPA-340/1-86-016, including updates and revisions.

(ii) Procedures for Certifying Quantity of Volatile Organic Compounds Emitted by Paint, Ink, and Other Coatings, EPA-450/3-84-019, including updates and revisions.

VII. ADDITIONAL REQUIREMENTS.**# 007 [25 Pa. Code §129.52d]****Control of VOC emissions from miscellaneous metal parts surface coating processes, miscellaneous plastic parts surface coating processes and pleasure craft surface coatings.**

**SECTION E. Source Group Restrictions.**

This source is subject to 25 Pa. Code Section 129.52d. The permittee shall comply with all applicable requirements specified in 25 Pa. Code Section 129.52d.



SECTION F. Alternative Operation Requirements.

No Alternative Operations exist for this State Only facility.



SECTION G. Emission Restriction Summary.

No emission restrictions listed in this section of the permit.



SECTION H. Miscellaneous.

The following air contaminant sources are considered to be insignificant in regards to air contaminant emissions and have been determined by the Department to be exempt from permitting requirements. However, this determination does not exempt the sources from compliance with all applicable State and Federal regulations and all applicable air quality regulations specified in 25 Pa. Code Chapters 121-145:

- (a) A natural gas fired pre-heat oven (Line 1) with a rated maximum gas throughput of 1020 scf/hr.
- (b) A natural gas fired curing oven (Line 2) with a rated maximum gas throughput of 360 scf/hr.
- (c) Propane tank.
- (d) Welding operations
- (e) Fabrication operations (i.e., cutting, drilling, sawing, grinding, etc.)
- (f) Small parts washer (cold cleaning machine) located in maintenance utilizing Safety Kleen solvent. This parts washer is subject to 25 Pa. Code Section 129.63(a) and shall comply with all applicable requirements specified in 25 Pa. Code Section 129.63(a).
- (g) Five natural-gas fired space heaters each rated 0.2 MMBtu/hr in Building 314
- (h) One 2.4 MMBtu/hr natural-gas fired heater in the Fabrication shop
- (i) Four natural-gas fired heaters each rated 0.054 MMBtu/hr in the Fabrication shop
- (j) Two natural-gas fired heaters each rated 0.144 MMBtu/hr in the main building
- (k) One 0.2 MMBtu/hr natural-gas fired heater in the Remac area

Revision #1: This permit was administratively amended on May 16, 2011, to revise the due dates of the reports required for Source ID P102. The due dates of January 1 and July 1 were revised to March 1 and September 1 respectively.

Revision #2: This permit was administratively amended on March 25, 2022, to revise the combined HAPs emission limit and the individual HAPs emissions limit for Sources P101 and P102 (combined).



***** End of Report *****
